

Dell™ Online Rack UPS 3750W and 4200W

User's Guide

K804N, H952N, 746FR (DeIIR42000LHVUS), J730N, K805N
J739N

Notes and Warnings



NOTE: A NOTE indicates important information that helps you make better use of your software.



DANGER: A DANGER indicates an imminently hazardous situation which, if not avoided, will result in death or serious injury.



WARNING: A WARNING indicates a potentially hazardous situation which, if not avoided, could result in death or injury.

A CAUTION indicates a potentially hazardous situation which, if not avoided, may result in minor or moderate injury or in property damage incidents.



DANGER: Observe the following instruction to help prevent an imminently hazardous situation which, if not avoided, will result in death or serious injury:

- This UPS contains **LETHAL VOLTAGES**. All repairs and service should be performed by **AUTHORIZED SERVICE PERSONNEL ONLY**. There are **NO USER SERVICEABLE PARTS** inside the UPS.
- This is Class A Interference Causing Equipment. In a residential environment, this product may cause radio interference, in which case the user may be required to take additional measures.

Information in this document is subject to change without notice.

© 2011–2013 Dell Inc. All rights reserved.

Reproduction in any manner whatsoever without the written permission of Dell Inc. is strictly forbidden.

Trademarks used in this text: *Dell* and the *DELL* logo are trademarks of Dell Inc.; *National Electrical Code* and *NEC* are registered trademarks of National Fire Protection Association, Inc.; *Phillips* is a registered trademark of Phillips Screw Company.

Other trademarks and trade names may be used in this document to refer to either the entities claiming the marks and names or their products. Dell Inc. disclaims any proprietary interest in trademarks and trade names other than its own.

Table of Contents

- 1 Introduction
 - Finding Information** 8
- 2 Safety Warnings
- 3 Installation
 - Inspecting the Equipment** 12
 - Unpacking the Cabinet** 13
 - Identifying the UPS Rear Panels** 15
 - Identifying the UPS Front Panel** 18
 - Rackmount Setup** 19
 - Installing the EBM** 25
 - Installing the UPS** 26
 - Installing Remote Emergency Power-off** 26
 - Hardwiring the UPS Input** 28
 - UPS Initial Startup** 30
- 4 Operation
 - UPS Startup and Shutdown** 32
 - Starting the UPS 32
 - Starting the UPS on Battery 33
 - UPS Shutdown 33
 - Control Panel Functions** 34
 - Changing the Language** 35

Display Functions	35
Startup Screen	35
Screen Locked	36
UPS Status	36
Event Log	39
Measurements	40
Control Screens	41
Identification	42
Settings	43
Transferring the UPS Between Modes	47
Transferring from Normal to Bypass Mode	47
Transferring from Bypass to Normal Mode	48
Setting Power Strategy	48
Retrieving the Event Log	49
Behavior on Overload	49
Configuring Load Segments	50
Controlling Load Segments Through the Display	50
Configuring Automatic Start Delay	51
Configuring Automatic on Battery Shutdown	52
Configuring Battery Settings	53
Configuring the UPS for an EBM	53
Running Automatic Battery Tests	54
Configuring Automatic Battery Tests	54
Configuring Automatic Restart	54
5 Additional UPS Features	
RS-232 and USB Communication Ports	55
Dell Network Management Card (Optional)	57
Dell UPS Management Software	58

6	UPS Maintenance	
	UPS and Battery Care	59
	Transporting the UPS	59
	Storing the UPS and Batteries	61
	When to Replace Batteries	61
	Testing Batteries	62
	Updating the UPS Firmware	62
7	Specifications	
8	Troubleshooting	
	Accessing Alarms and Conditions	67
	UPS Status Menu	67
	Event Log Menu	68
	Typical Alarms and Conditions	68
	Silencing the Alarm	72

Introduction

The Dell™ Online Rack uninterruptible power system (UPS) protects your sensitive electronic equipment from basic power problems such as power failures, power sags, power surges, brownouts, and line noise.

Power outages can occur when you least expect them and power quality can be erratic. These power problems have the potential to corrupt critical data, destroy unsaved work sessions, and damage hardware — causing hours of lost productivity and expensive repairs.

With the Dell Online Rack UPS, you can safely eliminate the effects of power disturbances and guard the integrity of your equipment. The UPS's flexibility to handle an array of network devices makes it the perfect choice to protect your LANs, servers, workstations, and other electrical equipment.

Figure 1 shows the Dell Online Rack UPS.

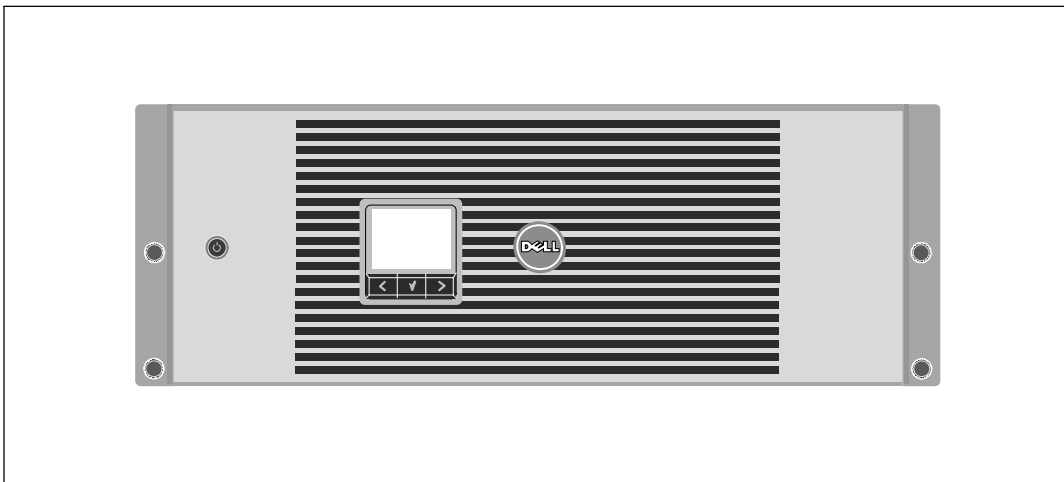

Figure 1. The Dell Online Rack UPS

Providing outstanding performance and reliability, the UPS's unique benefits include:

- Online UPS design with pure sine wave output. The UPS filters and regulates incoming AC power and provides consistent power to your equipment without draining the battery.
- True online double-conversion technology with high power density, utility frequency independence, and generator compatibility.
- Selectable High Efficiency mode of operation.
- 4U size that fits any standard 48 cm (19") rack.
- Start-on-battery capability for powering up the UPS even if utility power is not available.
- Maintenance is simplified by allowing the safe replacement of batteries without powering down the UPS.
- Extended runtime with an optional External Battery Module (EBM).
- Emergency shutdown control through the Remote Emergency Power-off (REPO) ports.
- Two standard communication ports (USB and DB-9 serial port).
- Optional Dell Network Management Card with enhanced communication capabilities for increased power protection and control.
- Advanced power management with the Dell UPS Management Software for graceful shutdowns and power monitoring.
- Sequential shutdown and load management through separate receptacle groups called load segments.
- Firmware that is easily upgradable without a service call.
- Backed by worldwide agency approvals.

Finding Information



CAUTION: The *Safety, Environmental, and Regulatory Information* document provides important safety and regulatory information.

What are You Looking For?	Find It Here
<ul style="list-style-type: none">• The user's guide for my UPS• The user's guide for the Dell Network Management Card• Dell UPS Management Software	<p>Dell UPS Disc</p>  <p>NOTE: Documentation and software updates can be found at www.support.dell.com and at www.dellups.com.</p>
<ul style="list-style-type: none">• Specifications• How to configure UPS settings• How to troubleshoot and solve problems• How to install REPO control	<p>Dell UPS User's Guide</p> <p>The user's guide is available on the Dell UPS disc and on www.support.dell.com.</p>
<ul style="list-style-type: none">• Safety instructions• Regulatory information• Recycling information	<p>Safety, Environmental, and Regulatory Information</p>
<ul style="list-style-type: none">• Warranty information• Terms and Conditions (U.S. only)• End User License Agreement	<p>Dell Warranty and Support Information</p>
<ul style="list-style-type: none">• Support information	<p>Dell Support Website — www.support.dell.com</p> <p>NOTE: Select your region or business segment to view the appropriate support site.</p>

Safety Warnings

 **CAUTION:** Before performing the procedures in this document, read and follow the safety instructions and important regulatory information in your *Safety, Environmental, and Regulatory Information* document.

IMPORTANT SAFETY INSTRUCTIONS SAVE THESE INSTRUCTIONS

This manual contains important instructions that you should follow during installation and maintenance of the UPS and batteries. Please read all instructions before operating the equipment and save this manual for future reference.

 **DANGER:** Observe the following instruction to help prevent an imminently hazardous situation which, if not avoided, will result in death or serious injury:

- This UPS contains **LETHAL VOLTAGES**. All repairs and service should be performed by **AUTHORIZED SERVICE PERSONNEL ONLY**. There are **NO USER SERVICEABLE PARTS** inside the UPS.

 **WARNING:** Observe the following instructions to help prevent a potentially hazardous situation which, if not avoided, could result in death or injury:

- Only qualified service personnel (such as a licensed electrician) shall perform the electrical installation. Risk of electrical shock.
- For UPS models with hardwired input, overcurrent protection for the output AC circuit(s) is to be provided by others.
- For UPS models with hardwired input, suitably rated disconnect switches for the output AC circuit(s) are to be provided by others.
- Output overcurrent protection and disconnect switch must be provided by others.
- This UPS contains its own energy source (batteries). The output receptacles may carry live voltage even when the UPS is not connected to an AC supply.
- Do not remove or unplug the input cord when the UPS is turned on. This removes the safety ground from the UPS and the equipment connected to the UPS.
- To reduce the risk of fire, connect only to a circuit provided with branch circuit overcurrent protection with an ampere rating in accordance with the National Electrical Code[®] (NEC[®]), ANSI/NFPA 70 or your local electrical code:

UPS Output Power	200V	208V	230V
3750W	—	30A	25A
4200W	30A	30A	30A

- To reduce the risk of fire or electric shock, install this UPS in a temperature and humidity controlled, indoor environment, free of conductive contaminants. Ambient temperature must not exceed 40°C (104°F). Do not operate near water or excessive humidity (95% maximum).
- Unpacking the cabinet in a low-temperature environment may cause condensation to occur in and on the cabinet. Do not install the cabinet until the inside and outside of the cabinet are absolutely dry (hazard of electric shock).
- If the UPS requires any type of transportation, disconnect the internal UPS batteries before transporting (see page 59).



CAUTION: Observe the following instructions to help prevent a potentially hazardous situation which, if not avoided, may result in minor or moderate injury or in property damage incidents:

- For PLUGABLE EQUIPMENT, the power outlet shall be installed near the equipment and shall be easily accessible.
- Servicing of batteries should be performed or supervised by personnel knowledgeable about batteries and the required precautions. Keep unauthorized personnel away from batteries.
- Batteries can present a risk of electrical shock or burn from high short-circuit current. The following precautions should be observed: 1) Remove watches, rings, or other metal objects; 2) Use tools with insulated handles; 3) Wear rubber gloves and boots; 4) Do not lay tools or metal parts on top of batteries; 5) Disconnect the charging source prior to connecting or disconnecting battery terminals.
- Determine if the battery is inadvertently grounded. If inadvertently grounded, remove the utility source from the ground. Contact with any part of a grounded battery can result in electrical shock. The likelihood of such shock can be reduced if such grounds are removed during installation and maintenance (applicable to equipment and remote battery supplies not having a grounded supply circuit).
- ELECTRIC ENERGY HAZARD. Do not attempt to alter any battery wiring or connectors. Attempting to alter wiring can cause injury.
- Replace batteries with the same number and type of batteries as originally installed in the UPS.
- Proper disposal of batteries is required. Refer to your local codes for disposal requirements.
- Never dispose of batteries in a fire. Batteries may explode when exposed to flame.
- Do not open or mutilate the battery or batteries. Released electrolyte is harmful to the skin and eyes and may be extremely toxic.
- The UPS may be connected to a maximum of one External Battery Module (EBM).



WARNING: Additional instructions for Rack-Mounted Systems

- Your rack kit has been approved only for the rack cabinet provided. It is your responsibility to ensure that installation of the equipment into any other rack complies with all applicable standards. Dell disclaims all liability and warranties with respect to combinations of equipment with any other rack.
- Before installing your equipment in a rack, install all front and side stabilizers. Failure to install stabilizers can allow the rack to tip over.
- Always load from the bottom up, and load the heaviest items first.
- Do not overload the AC power supply branch circuit that provides power to the rack.
- Do not stand or step on any components in the rack.



WARNING: Slide/rail mounted equipment is not to be used as a shelf or work space.





Do not add weight to slide/rail mounted equipment.

Operation

This chapter contains information on how to use the UPS, including:

- UPS startup and shutdown
- Control panel and display functions
- Retrieving the Event Log
- Transferring the UPS between modes
- Setting power strategy
- Behavior on overload
- Configuring load segments, battery settings, and automatic restart

UPS Startup and Shutdown

 **NOTE:** The  button controls only the UPS output. The  button has no effect on equipment connected to the UPS.

To start up or shut down the UPS, see:

- “Starting the UPS” on page 32
- “Starting the UPS on Battery” on page 33
- “UPS Shutdown” on page 33

Starting the UPS

To start the UPS:

- 1 Verify that the UPS power cord is plugged in.
- 2 Switch on utility power where the UPS is connected.

The UPS front panel display illuminates. The Dell startup screen changes to the UPS status summary screen. The UPS front panel display shows the Standby mode icon .

- 3 Press the  button on the UPS front panel.

After the startup is complete, the status icon changes to the appropriate icon based on the UPS operating mode (see Table 3 on page 37).

- 4 On the UPS status summary screen, press the **>** button to check for active alarms or notices. Resolve any active alarms before continuing. See “Troubleshooting” on page 67.

If there are no active alarms, a “No Active Alarms” message appears.

- 5 Verify that the Normal mode icon  appears on the UPS status summary screen, indicating that the UPS is operating normally and any loads are powered.

Starting the UPS on Battery

 **NOTE:** Before using this feature, the UPS must have been powered by utility power with output enabled at least once.



 **NOTE:** Utility power cannot be present at startup.

To start the UPS on battery:

- 1 Press the  button on the UPS front panel until the UPS beeps.

The UPS front panel display illuminates, and the UPS begins the startup sequence.

The UPS cycles through Standby mode to Battery mode. The Battery mode icon  displays on the UPS status summary screen. The UPS supplies power to your equipment.

 **NOTE:** The UPS does not assume the load if you press the  button less than three seconds.

- 2 Press the **>** button to check for active alarms or notices.

Ignore the “UPS on Battery” notice and notices that indicate missing utility power. Resolve other active alarms before continuing. See “Troubleshooting” on page 67. After correcting the alarms, restart if necessary.



You can prevent a battery start (requiring utility power at the next startup) by simultaneously pressing the **<** and **>** buttons for three seconds. Battery start can be disabled. See the Start on Battery setting on page 44.

UPS Shutdown

To shut down the UPS:

- 1 Press the  button on the front panel for three seconds.

The UPS begins to beep. The UPS transfers to Standby mode.

 **NOTE:** Releasing the  button before three seconds returns the UPS to its original operating state.

- 2 Switch off utility power where the UPS is connected.

After utility power is removed, the UPS fully shuts down in ten seconds.

Control Panel Functions

The UPS has a three-button graphical LCD with dual color backlight. Standard backlight is used to light up the display with white text and a blue background. When the UPS has a critical alarm, the backlight changes the text to dark amber and the background to amber. See Figure 23.

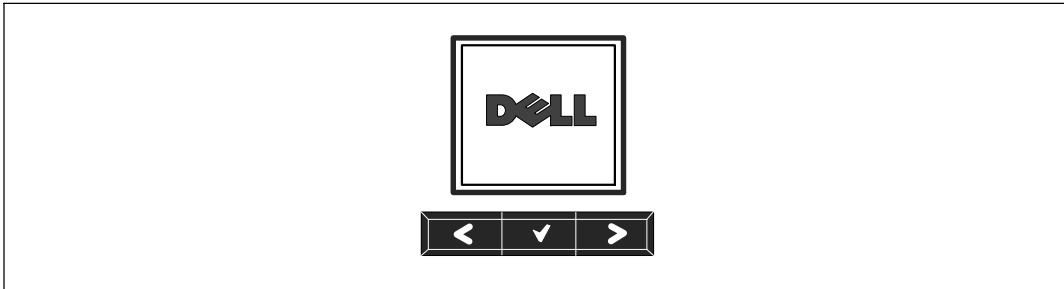

Figure 23. Dell Online Rack UPS Control Panel

There are three buttons on the control panel:

- < Scroll up or back
- ✓ Select
- > Scroll down or forward

Table 2 describes the functions of the LCD control buttons.

Table 2. Control Button Functions

Control Button	Sequence	Function
<	Press for less than one second	Scroll back or up to the previous menu.
<	Press for longer than one second	Return/exit back one menu layer without initiating a command or changing a setting.
✓	Press for less than one second	Select the menu or option to be changed.
✓	Press for longer than one second	Save the setting being edited.
>	Press for less than one second	Scroll forward or down to the next menu option.
< >	Press both buttons for three seconds	Temporarily disable the battery startup feature until the next power cycle. The buzzer emits a one second beep to indicate that Battery Start has been disabled.
< ✓ >	Press all three buttons for five seconds	Shortcut for defaulting the language back to English. The buzzer emits a one second beep to indicate that the setting has changed to English.

To select an option:

- 1 When scrolling through the settings, the present setting displays for each selection.
- 2 Press the **✓** button to select the option.
The current setting for the option flashes when selected.
- 3 Use the **<** or **>** buttons to toggle the available options.
- 4 Set the new option by holding the **✓** button again for one second.
The option stops flashing.

Changing the Language

Language selection is controlled through the user settings. See Table 6 page 43 for information on available languages.

Display Functions

The UPS provides useful information about the UPS itself, load status, events, measurements, identification, and settings through the front panel display.

Startup Screen

During startup, the Dell logo is the default screen. This startup screen displays for five seconds and then defaults to the UPS status summary screen.

The display automatically returns to the UPS status summary screen when no button has been pushed for 15 minutes and no other screen has been locked by a user. When you return to the status summary screen, press the **<** button for one second to exit back to the menu selections. Selecting UPS Status from the main menu list enables you to scroll through all of the UPS status menu screens, including the status summary screen.

Screen Locked

To lock a screen, press the **✓** button. The current view stays locked and does not automatically return to the default screen after time-out. When the screen is locked, the image of a key appears on the UPS status summary screen just to the left of the status icon. See Figure 24.

Pushing any button returns the normal button function, unlocks the screen, and removes the lock symbol.

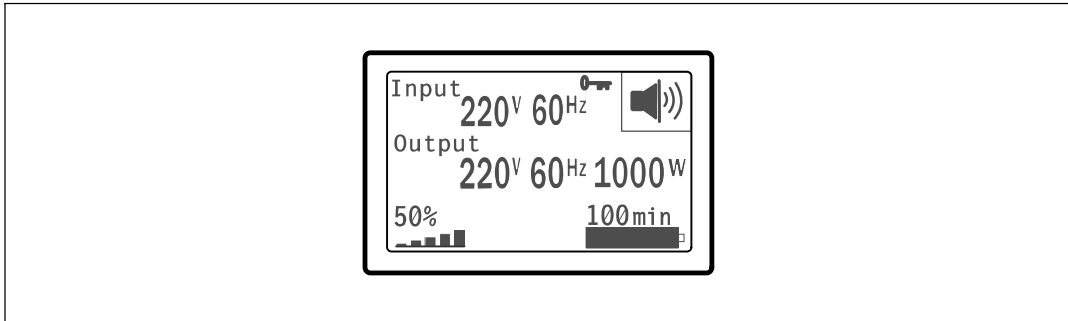

Figure 24. A Locked Screen

Only screens that have dynamic, real-time data updates can be locked. Applicable screens include the status summary screen, measurement screens, active alarms, and the battery status screen.

UPS Status

The UPS status provides separate screens for the following information:

- Status summary, including mode and load
- Notice or alarm status, if any are present
- Battery status, including state and charge level

See Table 3 for examples of the UPS status summary screens. The status icon in the upper right corner of each status summary screen conveys the UPS status or mode.

Basic operating modes include:

- Normal mode
- High-efficiency mode
- Battery mode
- Bypass mode
- Standby mode

Table 3. Status Summary Screens

Status Summary Screen	Description
 The screen displays 'Input 220V 60Hz' and 'Output 220V 60Hz 1000W'. A battery level indicator shows 50% and a timer shows 100min. A warning triangle icon is in the top right corner.	<p>UPS Critical Failure</p> <p>The UPS is in Fault mode. The status icon and background are flashing.</p>
 The screen displays 'Input 220V 60Hz' and 'Output 220V 60Hz 1000W'. A battery level indicator shows 50% and a timer shows 100min. A battery icon with a lightning bolt is in the top right corner.	<p>Battery Mode</p> <p>The status icon and background of the icon are flashing.</p> <p>An audible alarm (0.5 seconds on/4.5 seconds off) accompanies the switch to Battery mode.</p> <p>When the utility power returns, the UPS transfers to Normal mode operation while the battery recharges.</p>
 The screen displays 'Input 220V 60Hz' and 'Output 220V 60Hz 1000W'. A battery level indicator shows 50% and a timer shows 100min. A bypass switch icon is in the top right corner.	<p>Bypass Mode</p> <p>The UPS is operating in Bypass mode through the static bypass switch. The status icon and background of the icon are flashing. Battery mode is not available.</p>
 The screen displays 'Input 220V 60Hz' and 'Output 220V 60Hz 1000W'. A battery level indicator shows 50% and a timer shows 100min. A crossed-out power plug icon is in the top right corner.	<p>UPS in Overload Condition</p> <p>The status icon and background of the icon are flashing.</p>
 The screen displays 'Input 220V 60Hz' and 'Output 220V 60Hz 1000W'. A battery level indicator shows 50% and a timer shows 100min. A battery icon with a diagonal slash is in the top right corner.	<p>Bad Battery Detected or Battery Disconnected</p> <p>The status icon and background of the icon are flashing, along with the outer shell of the battery symbol at the bottom.</p>
 The screen displays 'Input 220V 60Hz' and 'Output 220V 60Hz 1000W'. A battery level indicator shows 50% and a timer shows 100min. A speaker icon is in the top right corner.	<p>UPS General Alarms Active</p> <p>The status icon and background of the icon are flashing.</p>

Table 3. Status Summary Screens (continued)

Status Summary Screen	Description
	<p>Battery Test Status</p> <p>The status when the UPS is performing a battery test.</p>
	<p>Normal Mode</p> <p>The UPS is operating in Normal mode from utility power. The UPS monitors and charges the batteries as needed and provides filtered power protection to your equipment.</p>
	<p>High Efficiency Mode</p> <p>The UPS is operating in High Efficiency mode.</p>
	<p>Converter Mode</p> <p>The UPS is operating in Converter mode.</p>
	<p>Standby Mode</p> <p>When the UPS is turned off and remains plugged into a power outlet, the UPS is in Standby mode and utility power supplies the connected equipment. The UPS is not supporting the load, but is ready to assume the load on command.</p>

The notice and alarm screens are visible only when notices or alarms are active. There is a separate screen for each active notice or alarm. If there are no active notices or alarms, a “No Active Alarms” message appears in a single screen between the UPS status summary and the battery status screen. If there are multiple notices or alarms, scroll through each notice or alarm screen to reach the first battery status screen.

 **NOTE:** Events are not shown in status summary screens. They appear only in the Event Log.

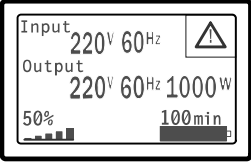
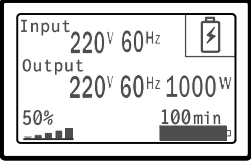
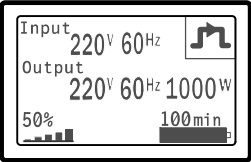
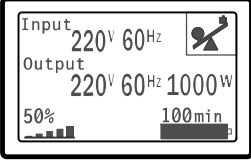
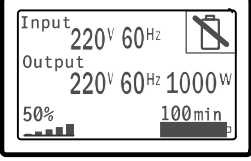
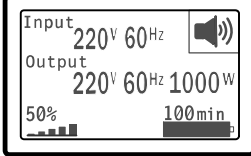
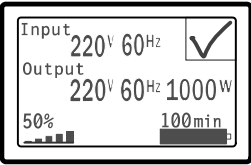
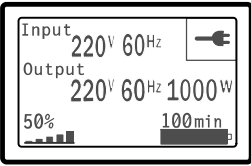
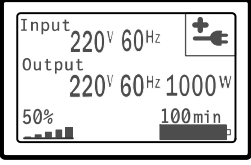
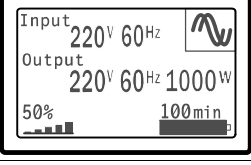
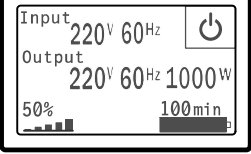
Table 4 describes the available battery status screens. Only one battery status is available at a time.

Table 4. Battery Status Screens

Battery Status Screen	Description
Battery charging	Batteries are charged in constant current mode.
Battery floating	Batteries are charged in constant voltage mode.
Battery resting	Batteries are connected but are not being charged or discharged. (This is part of the normal charging cycle.)
Battery discharging	Batteries are discharging.
Battery disconnected	Batteries are unavailable because they are disconnected.
Charger disabled	The battery charger is off. You can enable the Charger setting from the Settings menu (see page 46).

Event Log

The Event Log holds up to 50 events. You can scroll through the event screens, beginning with the most recent event.

 **NOTE:** The date format is dependent on the language selection.

The first row of each event screen contains the date (MM/DD/YYYY) and time (hh:mm:ss) at which the event occurred. The second row contains the type of event and code. The event description begins on the third row and may continue to the fourth row. The bottom right corner of the event screen displays two numbers: an ordering number of the event in the log, followed by the total number of events in the log.

If there are no events in the log, the event screen displays “No events in log.”

See “Retrieving the Event Log” on page 49.

Measurements

The measurements screens provide useful measurement information on:

- Output watts VA, current, power factor, voltage, and frequency
- Input voltage and frequency
- Battery voltage and percentage charged
- Instantaneous Headroom Watts remaining
- Peak Headroom Watts (the remaining watts available to support the load at peak demand, includes the date and timestamp of the peak demand)
- Peak Consumption Watts (the peak power demand on the UPS, includes the date and timestamp of the peak demand)
- Present kWh Consumption (the kWh demand on the UPS averaged over the past hour)
- Cumulative kWh Consumption (the total kWh usage, includes the date and timestamp since it was last reset)

Control Screens

Table 5 describes the available control screens.

Table 5. Control Screens

Control Screens	Description
Go to Bypass	<p>Transfers the UPS system to internal Bypass mode.</p> <p>When the Go to Bypass command is issued, the screen immediately shows the message for five seconds: Manual Bypass Command. The option then changes to Go to Normal.</p> <p>When the Go to Normal command is issued, the screen immediately shows the message Normal Mode Command Sent for five seconds. The option then changes to Go to Bypass.</p>
Battery Test	<p>Schedule Battery Test: yes Cancel Battery test: no</p> <p>Starts a manual battery test.</p> <p>See “Testing Batteries” on page 62.</p>
Reset Error State	<p>Reset Alarms: yes no</p> <p>Manually clears any latched alarms, such as bad battery detected or DC Bus OV/UV.</p> <p>If a bad battery alarm was also active, reset the battery test status to “Not Tested.”</p>
Load Segments	<p>Load segment 1: on off</p> <p>Load segment 2: on off</p> <p>These on/off commands override automatic load segment on/off controls made by the Automatic Start Delay and Automatic On Battery Shutdown settings. See “Configuring Load Segments” on page 50.</p>
Restore Factory Settings	<p>Restore Factory Settings: yes no</p> <p>Available only in Standby mode.</p> <p>Restoring the factory settings:</p> <ul style="list-style-type: none">• Returns all user-configurable EEPROM settings to default factory settings• Resets all pending on/off commands• Clears the Event Log and resets all time stamps• Resets the battery test status• Initiates the Self Diagnostics test

Identification

The identification screens display the following UPS information:

- Type and model
- Part number
- Serial number
- UPS firmware
- Network Management Card (NMC) firmware



NOTE: The NMC firmware screen displays only if the NMC is installed. See “Dell Network Management Card” on page 57.

Settings

Only available options are displayed.

User settings are not protected by default. You can enable the password through the User Password setting.

Table 6 displays the options that can be changed by the user.

Table 6. Settings

Description	Available Settings	Default Setting
Change Language	[English] [French] [German] [Spanish] [Japanese] [Simplified Chinese] [Russian] [Korean] [Traditional Chinese]	English
User Password	[Enabled] [Disabled] If Enabled, the default password is USER. NOTE: If you enter an incorrect password, the message “Wrong Password” appears. Press any button to return to the password screen and retry the password.	Disabled
Audible Alarms	[Enabled] [Disabled] NOTE: If you disable audible alarms, it takes effect instantly and remains disabled, even after a power cycle. This differs from the mute feature where the horn is temporarily silenced on any button press, but turns on again if a new alarm is triggered.	Enabled
Set Date and Time	Set Month, Day, Year, Hours, Minutes, and Seconds Date: mm/dd/yyyy Time: hh:mm:ss NOTE: The date format is dependent on the language selection. NOTE: Time is a 24-hour clock.	01/01/2009 12:00:00
Control Commands from Serial Port	[Enabled] [Disabled] If Enabled, control commands are accepted through the serial port, USB ports, or option card. If Disabled, configuration and load control commands are restricted to LCD only.	Enabled
Output Voltage	[200V] [208V] [220V] [230V] [240V] [Auto-sensing]	Auto-sensing
Output Frequency	[50Hz] [60Hz] [Auto-sensing]	Auto-sensing

Table 6. Settings (continued)

Description	Available Settings	Default Setting
Overload Alarm Level	[10%] [20%] [30%]...[100%] If 100%, the UPS issues an Output Overload alarm at load > 100%. NOTE: Output Overload Level 1 by default is set to 100% and is configurable from 10% to 100% in 10% increments through the LCD setting menu. This allows customers to be alerted before the UPS has reached its rated capacity limits.	100%
Power Strategy	[Normal] [High Efficiency] [Converter] See “Setting Power Strategy” on page 48.	High Efficiency
Automatic Start Delay	[Off] [0s] [1s] [2s]...[32767s] See “Configuring Load Segments” on page 50.	0s
Automatic on Battery Shutdown	[Off] [0s] [1s] [2s]...[32767s] See “Configuring Load Segments” on page 50.	Off
Start on Battery	[Enabled] [Disabled] NOTE: Battery start is disabled from the factory and remains disabled until the UPS has been powered from utility and enters Standby mode. After the UPS has been started once from utility, the Start on Battery feature is automatically enabled. After this is set by the user, it remains set.	Enabled
Battery Saving Mode	[Disabled] [10%] [20%] [30%]...[100%] The UPS output is turned off in five minutes if the UPS is on battery and output power is below the selected level.	Disabled
On Battery Notice Delay	[0] [1s] [2s]...[99s] The UPS issues a “UPS on battery” notice in the specified number of seconds after the UPS starts to discharge the batteries.	0s
Site Wiring Fault Alarm	[Enabled] [Disabled]	Enabled for low voltage models; Disabled for all other models

Table 6. Settings (continued)

Description	Available Settings	Default Setting
Bypass Voltage Low Limit	<p>[-6%] [-7%]...[-20%] of nominal</p> <p>The Bypass operation is disabled if the measured bypass voltage level is below the nominal output voltage (-15%).</p> <p>NOTE: The Qualify Bypass setting may overrule the Bypass Voltage Low Limit setting.</p>	-15% of nominal
Bypass Voltage High Limit	<p>[+6%] [+7%]...[+20%] of nominal</p> <p>The Bypass operation is disabled if the measured bypass voltage level is above the nominal output voltage (+10%).</p> <p>NOTE: The Qualify Bypass setting may overrule the Bypass Voltage High Limit setting.</p>	+10% of nominal
Qualify Bypass	<p>[Always] [Never] [Bypass Disabled]</p> <p>If Always, Bypass operation is allowed when:</p> <ul style="list-style-type: none"> • Bypass voltages > the value set for Bypass Voltage Low Limit • Bypass voltages < the value set for Bypass Voltage High Limit • Bypass frequency > (nominal frequency -3 Hz) • Bypass frequency < (nominal frequency +3 Hz) • Inverter is synchronized with Bypass when unsynchronized transfers are disabled by the value set for Unsynchronized Transfers <p>If Never, Bypass operation is always allowed; voltage and frequency limits are not in use.</p> <p>If Bypass Disabled, Bypass operation is prohibited.</p>	Always
Synchronization Window	<p>[Sync Disabled] [±0.5 Hz] [±1.0 Hz] [±1.5 Hz] [±2.0 Hz] [±2.5 Hz] [±3.0 Hz]</p> <p>If ±3.0 Hz, on inverter operation the inverter tries to synchronize with the Bypass when the Bypass frequency is not more than 3 Hz from the nominal output frequency; otherwise, the inverter goes to nominal frequency. On Bypass mode, the sync window is always ±3 Hz.</p> <p>NOTE: In Sync Disabled state, if the Bypass operation is allowed, the UPS synchronizes only when it is operating on Bypass mode.</p>	±3.0 Hz

Table 6. Settings (continued)

Description	Available Settings	Default Setting
Unsynchronized Transfers	[Enabled] [Disabled] If Enabled, unsynchronized transfers to the Bypass are allowed. If Disabled, unsynchronized transfers to the Bypass are not allowed. NOTE: The Qualify Bypass setting may overrule the Unsynchronized Transfers setting.	Enabled
External Battery Module (EBM)	[0] [1] See “Configuring the UPS for an EBM” on page 53.	0
Charger	[Enabled] [Disabled] If Enabled, batteries charge normally. If Disabled, the battery charger is off.	Enabled
Battery Charge % to Restart	[0 %] [10%] [20%] [30%]...[100%] When enabled, automatic restart is made when the battery charge state reaches the selected level. If set to 0, the feature is disabled.	0 %
Battery Low Alarm	[Immediate] [2 min] [3 min] [5 min] If you select a value, the battery low alarm triggers when the set amount of backup time (approximately) remains in the batteries. If Immediate, the battery low alarm activates at the same time as the “UPS on Battery” notice.	3 min
Automatic Battery Tests	[Enabled] [Disabled] See “Running Automatic Battery Tests” on page 54.	Enabled
Reset Peak Consumption Watts	[No] [Yes] If No, no action. If Yes, the Peak Consumption Watts value is cleared and the date and time stamp for this statistic is set to the current date and time.	No
Reset Cumulative Consumption kWh	[No] [Yes] If No, no action. If Yes, the Cumulative Consumption kWh value is cleared and the date and time stamp for this statistic is set to the current date and time.	No

Table 6. Settings (continued)

Description	Available Settings	Default Setting
Reset Peak Headroom Watts	[No] [Yes] If No, no action. If Yes, the Peak Headroom Watts value is cleared and the date and time stamp for this statistic is set to the current date and time.	No
Clear Event Log	The number after “Total events” shows how many events are currently stored in the log. Press the  button for one second to reset the event count to zero and clear the log.	—
LCD Contrast	[-5], [-4], [-3], [-2], [-1], [+0], [+1], [+2], [+3], [+4], [+5] The LCD Contrast is adjustable and the valid range is from -5 to +5. This range covers the maximum adjustment for contrasting the background with the text in the visual display of the control panel.	[+0]



Transferring the UPS Between Modes

Transferring between modes includes:

- Transferring from Normal to Bypass mode
- Transferring from Bypass to Normal mode

Transferring from Normal to Bypass Mode

To transfer from Normal to Bypass mode:

- 1 Press the  button for one second to go to the main menu selection and scroll down to the Control menu using the  button.
- 2 Press the  button to enter the Control menu.
- 3 Select Go to Bypass.

The text on the screen changes to Manual Bypass Command Sent. The Bypass mode icon  flashes, indicating Bypass mode.

Transferring from Bypass to Normal Mode

To transfer from Bypass to Normal mode:

- 1 Press the < button for one second to go to the main menu selection and scroll down to the Control menu using the > button.
- 2 Press the ✓ button to enter the Control menu.
- 3 Select Go to Normal.

The text on the screen changes to Normal Command Sent. The Normal mode icon  flashes, indicating Normal mode.

Setting Power Strategy

On the High Efficiency setting, the UPS operates normally on Bypass, transfers to inverter in ≤ 10 ms when utility power fails, and transfers back to Bypass in one minute after utility power returns. The Bypass mode status icon box appears on the UPS status summary screen when the UPS transfers to Bypass.

 **NOTE:** High Efficiency operation is available after one minute of stable power.

To set the power strategy:

- 1 Press the < button for one second to go to the main menu selection and scroll down to the Settings menu using the > button.
- 2 Press the ✓ button to enter the Settings menu.
- 3 Use the > button to scroll to Power Strategy and press the ✓ button.

The current setting for the option flashes when selected.

- 4 Select High Efficiency, Normal, or Converter using the < and > buttons.

The default is High Efficiency.

- 5 Press the ✓ button to confirm.

Retrieving the Event Log

To retrieve the Event Log through the display:

- 1 Press the < button for one second to go to the main menu selection and scroll down to the Event Log menu using the > button.
- 2 Press the ✓ button to enter the Event Log list.
- 3 Scroll through the listed events, notices, and alarms using either the < button or the > button.
- 4 To return to the main menu, press the < button for one second. The Event Log displays.
- 5 Press the > button. The UPS status screen displays.

Behavior on Overload

See Table 7 for an explanation of how the UPS responds to an overload condition.

Table 7. Behavior on Overload

Overload Severity	Load Level	On Utility Power	On Bypass/High Efficiency Mode	On Battery
Level 1	Load 100% to 101%	Overload alarm only and support load indefinitely	Overload alarm only and support load indefinitely	Overload alarm only, support load until low battery shutdown level is reached
Level 2	Load 102% to 110%	Transfer to Bypass after 12 seconds (± 1 sec) If Bypass is not available, transfer to Fault mode after 12 seconds (± 1 sec)	Transfer to Fault mode in 2 minutes (± 1 sec)	Transfer to Fault mode after 12 seconds (± 1 sec) or until low battery shutdown level is reached
Level 3	Load > 110%	Transfer to Bypass immediately If Bypass is not available, transfer to Fault mode in 300 ms to 1 sec	Transfer to Fault mode in 300 ms to 1 sec	Transfer to Fault mode in 300 ms to 1 sec

Configuring Load Segments

Load segments are sets of receptacles that can be controlled by the Dell UPS Management Software, the Dell Network Management Card, or through the LCD display, providing an orderly shutdown and startup of your equipment. For example, during a power outage, you can keep key pieces of equipment running while you turn off other equipment. This feature allows you to save battery power.

Each Dell Online Rack model has two configurable load segments. See “Identifying the UPS Rear Panels” on page 15 for the load segment locations.

To control the load segments with power management software, see your power management software manual for details (refer to the Software CD or www.dell.com for the latest information).

Controlling Load Segments Through the Display

To control the load segments through the display:

- 1 Press the **<** button for one second to go to the main menu selection and scroll down to the Control menu using the **>** button.
- 2 Press the **✓** button to enter the Control menu.
- 3 Use the **>** button to scroll to Load Segments.
- 4 Press the **✓** button.
The current setting for the option flashes when selected.
- 5 Select the desired load segment using the **<** and **>** buttons.
- 6 Set the desired load segment ON or OFF using the **✓** button.
- 7 Press the **✓** button to confirm.
- 8 Set the other load segment if applicable.









Configuring Automatic Start Delay

You can configure the load segment to turn on automatically after the utility power returns, if it was shut down by:

- The  button
- An external command with auto-restart option
- Battery under voltage state
- Automatic on battery shutdown command

You can specify the restart delay time for each load segment: select zero seconds (0s is the default) to restart immediately, select 1–32767 seconds to delay for the specified time, or select Off.

To set the restart delay times for each load segment:

- 1 Press the  button for one second to go to the main menu selection and scroll down to the Settings menu using the  button.
- 2 Press the  button to enter the Settings menu.
- 3 Use the  button to scroll to the Automatic Start Delay option and press the  button.
The current setting for the option flashes when selected.
- 4 Set the restart delay for one load segment using the  and  buttons.
- 5 Press the  button to confirm.
- 6 Set the restart delay for the other load segment if applicable.
- 7 Press the  button to confirm.

 **NOTE:** Load segment On/Off commands issued through the Control menu override the user settings for load segments.

 **NOTE:** A single load segment delay applies to both outlets. However, there is an additional built-in one-second delay between closing segment 1 and 2. The delay is always present when an On command is issued for both segments at the same time.









Configuring Automatic on Battery Shutdown

If set to Off (default), the load segment turns off only when commanded manually by the  button, an external command, or through the display (Control > Load Segments).

If set to zero seconds (0s), the load segment turns off automatically when the UPS on Battery state activates.

If you select a value, the load segment turns off automatically after the selected delay while the UPS operates on battery, but the shutdown is cancelled if the utility returns before the delay has expired.

To set the shutdown times for each load segment:

- 1 Press the  button for one second to go to the main menu selection and scroll down to the Settings menu using the  button.
- 2 Press the  button to enter the Settings menu.
- 3 Use the  button to scroll to the Automatic on Battery Shutdown option and press the  button.
The options display and the current settings flash when selected.
- 4 Set the shutdown delay for one load segment using the  and  buttons.
- 5 Press the  button to confirm.
- 6 Set the shutdown delay for the other load segment if applicable.
- 7 Press the  button to confirm.

Configuring Battery Settings

Configure the UPS settings for an installed EBM, including whether to run automatic battery tests and automatic restart configuration.

Configuring the UPS for an EBM

If the UPS is not configured for the EBM, the UPS reports less battery time remaining on the UPS front panel and to any remote software. You may receive a shutdown warning prematurely. To ensure maximum battery runtime when using power management software, configure the UPS for the EBM:

- 1 Press the < button for one second to go to the main menu selection and scroll down to the Settings menu using the > button.
- 2 Press the ✓ button to enter the Settings menu.
- 3 Use the > button to scroll to the External Battery Module option and press the ✓ button.
The battery number value begins to flash.
- 4 Set the battery number value using the < and > buttons.

Configuration	Setting
UPS only (internal batteries)	0 (default)
UPS + 1 EBM	1

NOTE: Runtime is automatically adjusted based on present load levels and whether an EBM is configured.

- 5 Press the ✓ button to confirm.

Running Automatic Battery Tests

The automatic discharge test, enabled by default, runs during the transition from Float to Rest mode. After the test completes, the charge cycle restarts to completely charge the batteries and then continues to Rest mode normally. The automatic test runs approximately once every three months and does not run again until after three more Float to Rest mode transitions. If a manual battery test is requested, the automatic battery test timer is reset so it will not run for the next three months.

For an automatic battery test to run:

- The Automatic Battery Tests setting must be enabled for the automatic battery tests to run. (See the following section, “Configuring Automatic Battery Tests.”)
- The batteries must be fully charged.
- The UPS must be in Normal mode or High Efficiency mode with no active alarms.
- The load must be higher than 10%.

Configuring Automatic Battery Tests

To configure the automatic battery tests:

- 1 Press the < button for one second to go to the main menu selection and scroll down to the Settings menu using the > button.
- 2 Press the ✓ button to enter the Settings menu.
- 3 Use the > button to scroll to the Automatic Battery Tests option and press the ✓ button. The option begins to flash.
- 4 Select whether to enable or disable the automatic battery test using the < and > buttons.
- 5 Press the ✓ button to confirm.

Configuring Automatic Restart

The UPS automatically restarts if the utility power returns after the output was shut off due to depleted batteries, a shutdown input signal, or automatic shutdown command.

You can set the load segment for the amount of time to delay the restart when utility power returns, using the Automatic Start Delay setting. You can also configure UPS restart to depend on the battery charge level, using the Battery Charge % to Restart setting.

Additional UPS Features

This chapter describes:

- Communication ports (RS-232 and USB)
- Dell Network Management Card
- Dell UPS Management Software

RS-232 and USB Communication Ports

To establish communication between the UPS and a computer, connect your computer to one of the UPS communication ports using an appropriate communication cable (RS-232 cable not supplied). See “Identifying the UPS Rear Panels” on page 15 for the communication port locations.

When the communication cable is installed, power management software can exchange data with the UPS. The software polls the UPS for detailed information on the status of the power environment. If a power emergency occurs, the software initiates the saving of all data and an orderly shutdown of the equipment.

The cable pins for the RS-232 communication port are identified in Figure 25, and the pin functions are described in Table 8.

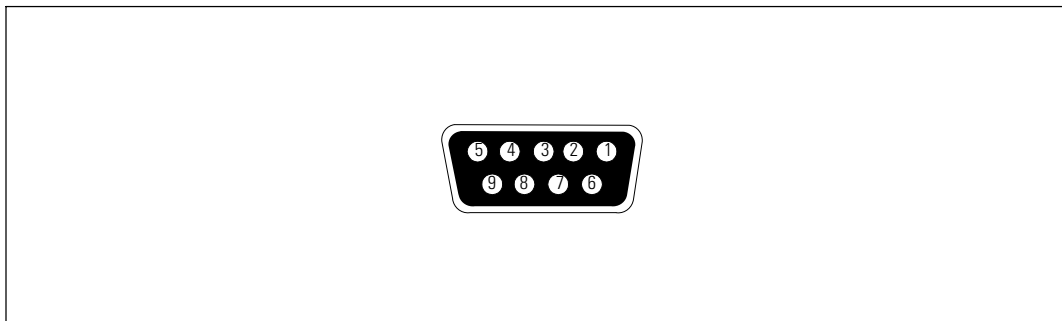

Figure 25. RS-232 Communication Port (DB-9 Connector)

Table 8. RS-232 Communication Port Pin Assignment

Pin	Signal Name	Function	Direction from the UPS
1		Unused	—
2	Tx	Transmit to external device	Out
3	Rx	Receive from external device	In
4		Unused	—
5	GND	Signal common (tied to chassis)	—
6		Unused	—
7		Unused	—
8		Unused	—
9		Unused	—

*Unused pins must be left free on all models.

Dell Network Management Card (Optional)

The Dell Online Rack UPS has one available communication bay, which supports the optional Dell Network Management Card. See Figure 26 for the location of the communication bay.

It is not necessary to shut down the UPS before installing a communication card.

- 1 Remove the slot cover secured by two screws. Retain the screws.
- 2 Insert the communication card into the slot.
- 3 Secure the card with both screws.

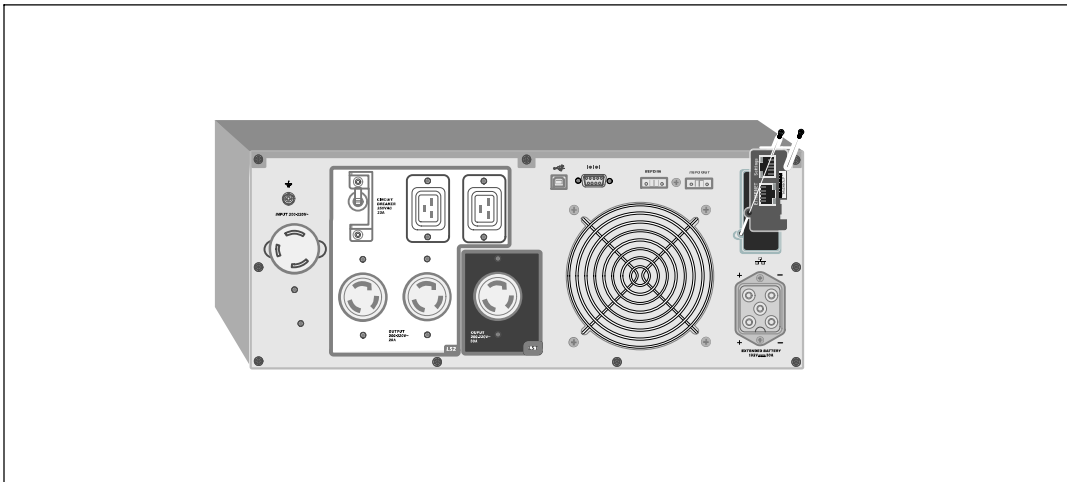

Figure 26. Dell Network Management Card

For details on disabling control commands from the Dell Network Management Card, see the Control Commands from Serial Port setting on page 43.

Refer to the *Dell Network Management Card User's Guide* for more information.

The LAN card transfer rate is 10/100 Mbps.

Dell UPS Management Software

Each Dell Online Rack UPS ships with Dell UPS Management Software.

Dell UPS Management Software provides up-to-date graphics of UPS power and system data and power flow. It also gives you a complete record of critical power events, and it notifies you of important UPS or power information. If there is a power outage and the Dell Online Rack UPS battery power becomes low, the software can automatically shut down your computer system to protect your data before the UPS shutdown occurs.

For details on disabling control commands from the software, see the user setting for Control Commands from Serial Port setting on page 43.

UPS Maintenance

This chapter explains how to:

- Care for the UPS and batteries
- Transport the UPS
- Store the UPS and batteries
- Test the batteries
- Update the UPS firmware

UPS and Battery Care

For the best preventive maintenance, keep the area around the UPS clean and dust-free. If the atmosphere is very dusty, clean the outside of the system with a vacuum cleaner. For full battery life, keep the UPS at an ambient temperature of 25°C (77°F).

 **NOTE:** The batteries in the UPS are rated for a 3–5 year service life. The length of service life varies, depending on the frequency of usage and ambient temperature. Batteries used beyond expected service life will often have severely reduced runtimes. Replace batteries at least every 5 years to keep units running at peak efficiency.

Transporting the UPS

 **NOTE:** The internal UPS batteries MUST be disconnected before transportation.

 **CAUTION:** The following procedure should be performed or supervised by personnel knowledgeable about batteries and the required precautions. Keep unauthorized personnel away from batteries.

If the UPS requires any type of transportation, the batteries must be disconnected (but not removed) before the unit is transported:

- 1 Verify that the UPS is off and unplugged.
- 2 Place the UPS on a flat, stable surface with the front of the cabinet facing you.

- 3 Remove the UPS front cover (see Figure 27).

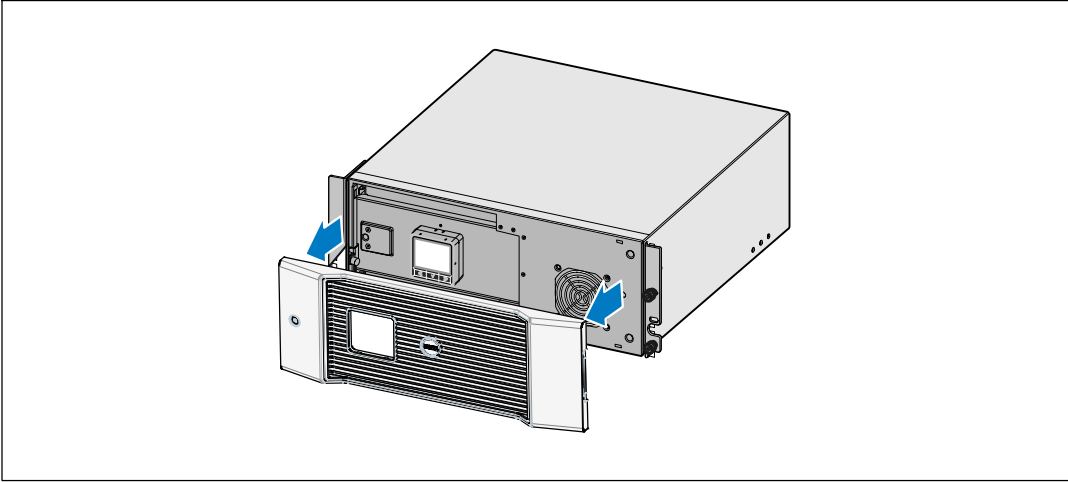

Figure 27. Removing the UPS Front Cover

- 4 Disconnect the internal battery connectors (see Figure 28).

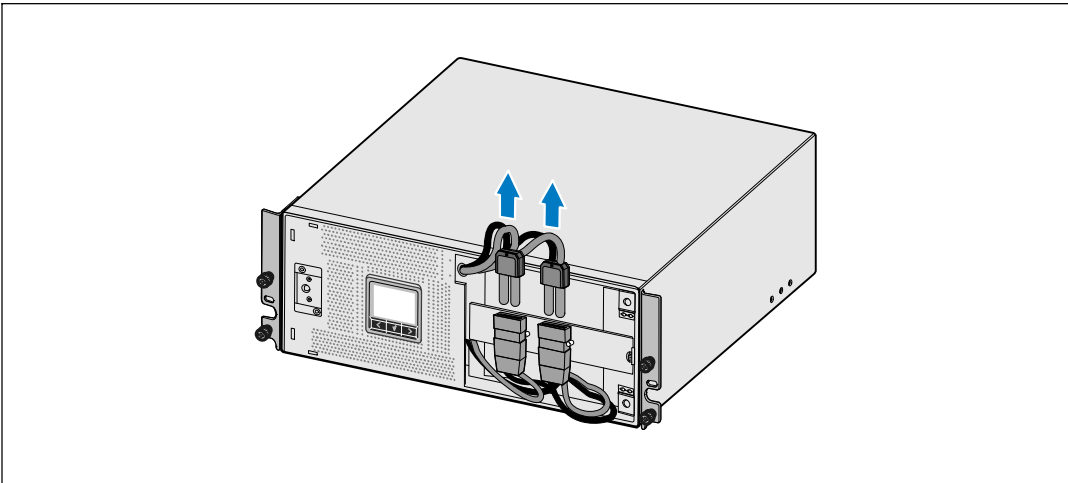

Figure 28. Disconnecting the Internal Battery Connector

- 5 Replace the UPS front cover (see Figure 29).

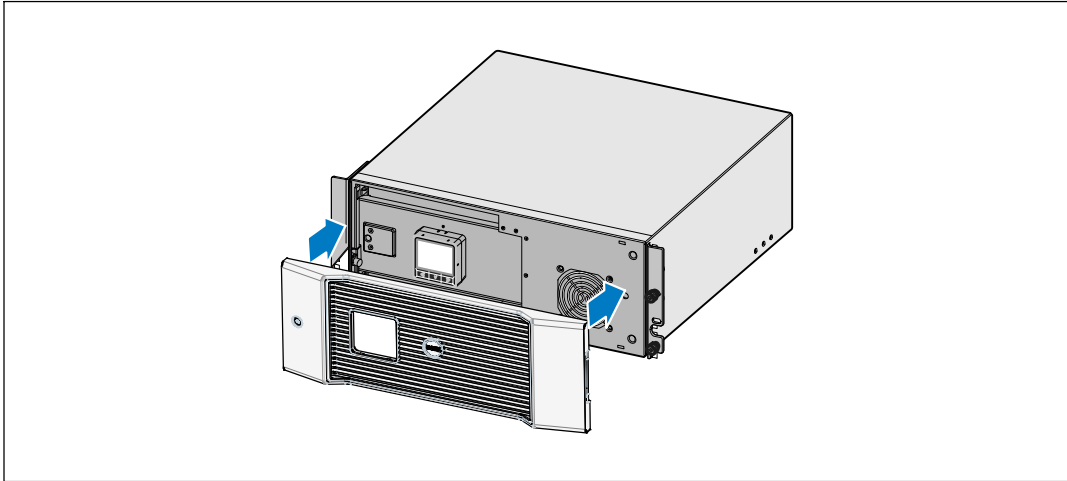

Figure 29. Replacing the UPS Front Cover

Storing the UPS and Batteries

If you store the UPS for a long period, recharge the battery every 6 months by plugging the UPS into a power outlet. The batteries charge to 90% capacity in approximately 4 hours. However, it is recommended that the batteries charge for 48 hours after long-term storage.

Check the battery recharge date on the shipping carton label. If the date has passed and the batteries were never recharged, do not use the UPS. Contact your service representative.

When to Replace Batteries

When the status summary screen displays the UPS fault icon with the “Service Battery” alarm and the audible alarm sounds continuously, the batteries may need replacing. Contact your service representative to order new batteries.



NOTE: With the user-replaceable battery feature, UPS batteries can be replaced easily without turning the UPS off or disconnecting the load.

Testing Batteries

For a battery test to run:

- The batteries must be fully charged.
- The UPS must be in Normal mode or High Efficiency mode with no active alarms.
- The load must be higher than 10%.

To test batteries:

- 1 Plug the UPS into a power outlet for at least 48 hours to charge the batteries.
- 2 Press the < button for one second to go to the main menu selection and scroll down to the Control menu using the > button.
- 3 Press the ✓ button to enter the Control menu.
- 4 Use the > button to scroll to the Battery Test option.
- 5 Press the ✓ button to start the battery test.

During the battery test, the UPS transfers to Battery mode and discharges the batteries for 25% of the original expected runtime. The front panel displays “Battery test running” and the percentage of the test completed. The results display on the UPS front panel when complete.

Updating the UPS Firmware

To keep the UPS firmware updated with the latest improvements and benefits, visit www.dell.com for updates. You can download the latest firmware version and the instructions for installing it.

Specifications

This chapter provides the following specifications:

- Model list
- Dimensions and weights
- Electrical input and output
- Environmental and safety
- Battery
- UPS block diagram

Table 9. UPS Model List

	200V Model	208V Model	230V Models
UPS Models	DellR4200OLHVUS (746FR), 4200W	3750R OL (K804N), 3750W 4200R OL (J730N), 4200W	3750R OL (H952N), 3750W 4200R OL (K805N), 4200W
External Battery Module (EBM)	3750R and 4200R EBM (J739N), 192 Vdc/30A		

Table 10. Dimensions and Weights

	UPS Models	EBM Model
UPS Dimensions (W × H × D)	438.0 × 171.5 × 801.4 mm (17.2" × 6.8" × 31.5") - 4U	438.0 × 127.0 × 735.0 mm (17.2" × 5.0" × 29.0") - 3U
Weights	66.0 kg (145.5 lb)	53.0 kg (116.8 lb)

Table 11. Electrical Input

	200V Models	208V Models	230V Models
Nominal Voltage	200–240V	200–220V	220–240V
Voltage Range (Engineering Specifications)	160–286V auto-sensing	155–255V auto-sensing	160–286V auto-sensing
Nominal Frequency	50/60 Hz auto-sensing, ±3 Hz		
Efficiency (Normal mode)	>95%		
Noise Filtering	Full-time EMI/RFI filtering		
Connections	4200W: Hardwired	3750W: 2m, L6-30P attached power cord 4200W: Hardwired	3750W: Hardwired 4200W: Hardwired

Table 12. Electrical Output

	200V Models	208V Models	230V Models
Power Levels (rated at nominal inputs)	4200W	3750W 4200W	3750W 4200W
Regulation (Normal mode)	-6% to +6% of nominal voltage NOTE: This varies based on auto-detected input voltage or customer settings.		
Regulation (Battery mode), Nominal Voltage ±5%	-6% to +6% of nominal voltage NOTE: This varies based on auto-detected input voltage or customer settings.		
Voltage Waveform	Sine wave		
Output Receptacles	4200W:(6) IEC 320-C13; 10A for IEC, 15A for UL (4) IEC 320-C19, 16A for IEC, 20A for UL	3750W: (2) L6-20R; 20A (1) L6-30R, 30A (2) IEC 320-C19, 20A 4200W: (2) L6-20R; 20A (1) L6-30R, 30A (4) IEC 320-C19, 20A	3750W:(8) IEC 320-C13; 10A for IEC, 15A for UL (2) IEC 320-C19, 16A for IEC, 20A for UL 4200W:(6) IEC 320-C13; 10A for IEC, 15A for UL (4) IEC 320-C19, 16A for IEC, 20A for UL

Table 13. Environmental and Safety

	200V Models	208V Models	230V Models
Operating Temperature	Up to 1,500 meters: 0°C to 40°C (32°F to 104°F); UL tested 25°C (77°F) Above 1,500 meters: 0°C to 35°C (32°F to 95°F)		
Transit/Storage Temperature	-15°C to 60°C (5°F to 140°F)		
Relative Humidity	0–95% noncondensing		
Operating Altitude	Up to 3,048 meters (0–10,000 ft) above sea level		
Audible Noise	Less than 55 dBA on line/bypass mode (less than 75% load), room temperature		
Fan Speed	Low speed: when the load is < 80% High speed: when the load is >80% or the UPS is in Battery mode		
Surge Suppression	ANSI/IEEE C62.41; 1991 Category B3		
Safety Conformance	UL 1778 4th Edition; CSA C22.2, No. 107.3; IEC/EN 62040-1-1; IEC/EN 60950-1	UL 1778 4th Edition; CSA C22.2, No. 107.3	UL 1778 4th Edition; CSA C22.2, No. 107.3; IEC/EN 62040-1-1; IEC/EN 60950-1
Safety Markings	UL, cUL, CE, GS, GOST, BSMI, S-MARK, KC, NRCS, C-tick	UL, cUL, VCCI	UL, cUL, CE, GS, GOST, BSMI, S-MARK, KC, NRCS, C-tick
EMC (Class A)	IEC/EN 62040-2; EN 55022/CISPR 22; ICES-003; CNS14757-2; AS/NZS 62040.2; FCC Part 15; KN22; GB7260.2; EN 55024/CISPR 24	FCC Part 15, ICES-003, VCCI	IEC/EN 62040-2; EN 55022/CISPR 22; ICES-003; CNS14757-2; AS/NZS 62040.2; FCC Part 15; KN22; GB7260.2; EN 55024/CISPR 24

Table 14. Battery

Configuration	3700W: (16) 12V, 7.2 Ah internal batteries; (16) 12V, 7.2 Ah EBM 4200W: (16) 12V, 7.2 Ah internal batteries; (16) 12V, 7.2 Ah EBM
Battery Type	CSB GPI272 7.2 Ah or YUASA NP7-12 7Ah
Voltage	3750W: 192 Vdc internal, 192 Vdc/30A EBM 4200W: 192 Vdc internal, 192 Vdc/30A EBM
Fuses	UPS: (1) 30A fuse EBM: (1) 30A fuse
Type	Sealed, maintenance-free, valve-regulated, lead-acid
Charging	Approximately 4 hours to 90% usable capacity at nominal line and no supplementary power supply load
Monitoring	Advanced monitoring for earlier failure detection and warning
Battery Runtimes*	3750W internal batteries: 5 minutes at full load/21 minutes at half load 4200W internal batteries: 5 minutes at full load/16 minutes at half load 3750W with one EBM attached: 14 minutes at full load/43 minutes at half load 4200W with one EBM attached: 11 minutes at full load/35 minutes at half load

*Battery runtimes are approximate and vary depending on the load configuration and battery charge.

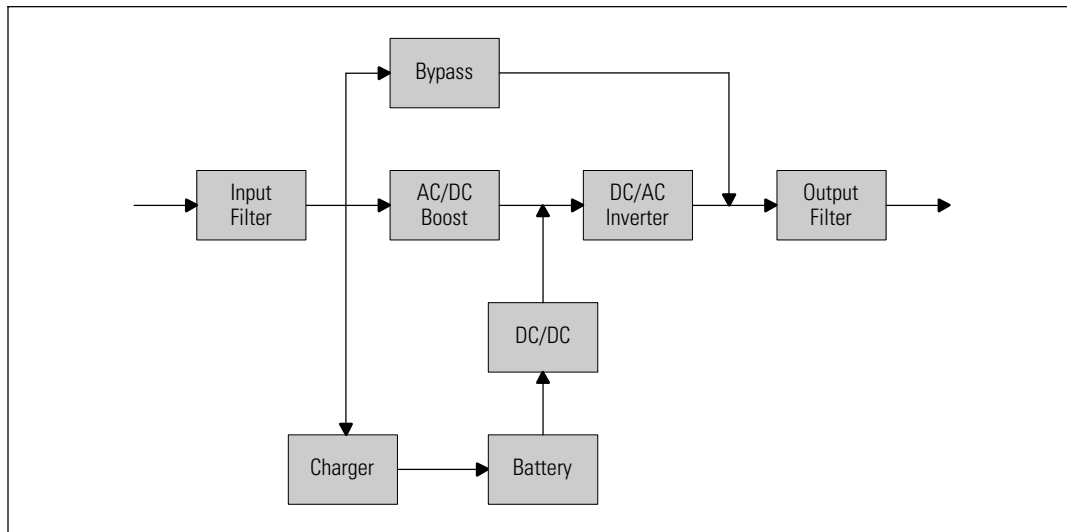

Figure 30. Online UPS Block Diagram

Troubleshooting

The Dell Online Rack UPS is designed for durable, automatic operation and issues alarms to alert you whenever potential operating problems occur. Usually the alarms shown by the control panel do not mean that the output power is affected. Instead, they are preventive alarms intended to alert the user. Active alarms and active notices are accompanied by an audible buzzer.

Accessing Alarms and Conditions

The control panel provides troubleshooting information from two main menus:

- **UPS Status menu:** access to all active alarms
- **Event Log menu:** access to the most recent 50 events, which may include active and closed alarms

UPS Status Menu

From the UPS Status menu, you can access the following screens for troubleshooting information:

- **Status summary screen:** The status summary screen provides information on both mode and load. When there is a critical alarm, the status summary screen changes from its normal white text on a blue background to dark amber text on an amber background.
- **Notice or alarm screens:** A separate screen appears for each active notice or alarm. If there are no active alarms or notices, the display reads “No Active Alarms.”
- **Battery status screen:** The battery status screen indicates the battery charge mode, the percent the battery is charged, and the runtime with the present load level.



NOTE: When an alarm is active, the control panel automatically displays an active alarm screen unless the screen lock is enabled by the user.

To access troubleshooting information using the UPS Status menu:

- 1 Press the < button for one second to go to the main menu selection.
- 2 Press the ✓ button to access the UPS Status menu.
- 3 Press the > button to access the UPS status summary screen.

The UPS status summary screen provides load information. The status icon indicates the UPS operating mode (see Table 3 on page 37).

- 4 Use the > button to scroll through the active notice and active alarm screens.
- 5 After scrolling through all alarms, press the > button to access the Battery Status screen.

Event Log Menu

From the Event Log menu, you can access the last 50 events, which includes events, notices, and alarms, arranged from newest to oldest.

Events are silent conditions that are recorded in the Event Log as status information, such as “Clock Set Done.” Events do not require a response.

Notices and alarms are records of when events occurred and, if applicable, when they were cleared.

- Notices, including active notices, are recorded in the Event Log. Active notices, such as “UPS on Battery,” are announced by an intermittent beep. Notices do not normally require a response.
- Alarms, including active alarms, are recorded in the Event Log. Active alarms are announced by an intermittent beep. Examples are “Output Overload” and “Heatsink Overtemperature.” Active alarms require a response.

The Main Status Menu displays by default. To access troubleshooting information using the Event Log menu:

- 1 Press the **<** button for one second to go to the main menu selection and scroll down to the Event Log menu using the **>** button.
- 2 Click the **✓** button to enter the Event Log list.
- 3 Scroll through the listed events, notices, and alarms using the **>** or **<** button.

Typical Alarms and Conditions

Table 15 describes typical alarms and conditions.

Table 15. Typical Alarms and Conditions

Alarm or Condition	Possible Cause	Action
The UPS does not provide or indicate the expected backup time.	The batteries need charging or service.	Apply utility power for 48 hours to charge the batteries. If the condition persists, contact your service representative.
Power is not available at the UPS output receptacles.	The UPS is in Standby mode.	Supply power to the connected equipment by pressing the On/Off button until the front panel displays the UPS status summary screen.
The UPS does not start. (The LCD is off.)	Power is not connected.	Check the power connections. Also ensure that the battery is plugged in.
The UPS operates normally, but some or all of the protected equipment is not on.	The equipment is not connected correctly to the UPS.	Verify that the equipment is plugged into the UPS receptacles. Also verify that the load segment is on.

Table 15. Typical Alarms and Conditions (continued)

Alarm or Condition	Possible Cause	Action
Battery test did not run or was interrupted.	One of the conditions listed in “Running Automatic Battery Tests” on page 54 was not present.	Resolve the condition, then restart the test.
The UPS does not transfer to Bypass mode.	The bypass utility does not qualify.	Check the bypass utility. The UPS is receiving bypass utility power that may be unstable or in brownout conditions.
	Bypass mode is disabled.	Check that the Bypass settings are configured correctly. See “Settings” on page 43.
UPS on Bypass (Notice 169) Continuous Alarm	The UPS is operating from Bypass mode.	The equipment transferred to bypass utility power. Battery mode is not available and your equipment is not protected; however, the utility power continues to be passively filtered by the UPS. Check for one of the following alarms: overtemperature, overload, or UPS failure.
On Manual Bypass (Notice 143) Intermittent Alarm	UPS was manually commanded to transfer to Bypass mode and will remain in bypass until commanded.	None.
UPS on Battery (Notice 168) Intermittent Alarm	A utility failure has occurred and the UPS is in Battery mode.	The UPS is powering the equipment with battery power. Prepare your equipment for shutdown.
Battery Disconnected (Alarm 199) Continuous Alarm	The UPS does not recognize the internal batteries.	If the condition persists, contact your service representative.
	Battery voltage is lower than the batteries disconnected level defined for this UPS. This may be due to a blown fuse, intermittent battery connection, or battery cable being disconnected.	Verify that all batteries are properly connected. If the condition persists, contact your service representative.
Low Battery Warning (Alarm 56) Continuous Alarm	Battery time remaining or battery capacity is lower than the battery low warning level defined for this UPS.	This warning is approximate. The actual time to shutdown may vary depending on the UPS load and presence of an External Battery Module (EBM).

Table 15. Typical Alarms and Conditions (continued)

Alarm or Condition	Possible Cause	Action
Shutdown Imminent (Alarm 55) Continuous Alarm	Communication to external devices stops because the UPS has entered a state where it may abruptly stop operating without further notice unless utility returns.	The alarm is issued when the battery time remaining reaches zero. All connected devices should have already shut down gracefully.
Battery Test Failed (Alarm 191) Intermittent Alarm	A weak battery string was detected during the last battery test.	This is a warning notice. Dell recommends that you replace the batteries soon.
Service Battery (Alarm 149) Continuous Alarm	A faulted battery string has been detected and as a result, the charger is disabled.	Contact your service representative.
Utility Not Present (Alarm 59) Intermittent Alarm	Utility level has fallen below the Utility Not Present threshold (typically <25 to 50V).	Transfer to battery if supporting load. Power down if not supporting load.
Bypass Not Available (Alarm 105)	Utility is outside of the bypass limits defined in the UPS.	Check the bypass settings. See “Settings” on page 43.
Input AC Over Voltage (Alarm 6) Intermittent Alarm	Utility voltage exceeds the maximum operating range.	The UPS transfers to Battery mode if supporting load.
Input AC Under Voltage (Alarm 7) Intermittent Alarm	Utility voltage is below the minimum operating range.	The UPS transfers to Battery mode if supporting load.
Input Under/Over Frequency (Alarm 8) Intermittent Alarm	The utility frequency is out of usable frequency range.	The UPS transfers to Battery mode if supporting load.
Site Wiring Problem (Alarm 194) Continuous Alarm	An alarm triggers when the difference between ground and neutral voltage is >15V.	Have a qualified electrician correct the wiring problem. If the UPS is not wired with a neutral wire, Site Fault should be disabled in the Settings menu (see page 43).
Remote Emergency Power Off (Alarm 12) Continuous Alarm	The external contacts in the rear of the UPS are configured for REPO operation and they have been activated.	The UPS de-energizes the load and enters Standby mode. See “Installing Remote Emergency Power-off” on page 26 for more information.

Table 15. Typical Alarms and Conditions (continued)

Alarm or Condition	Possible Cause	Action
Output Overload (Alarm 25) Continuous Alarm	The load level is at or has exceeded the configurable threshold limit for a Level 1 Overload condition.	The UPS can support the load indefinitely at this load level. The alarm clears when the load drops below 5% of the set point.
Output Overload Level 2 (Alarm 159) Continuous Alarm	The load level is >101% and <110% of the UPS rating.	Remove some of the equipment from the UPS. The UPS continues to operate, but transfers to Fault mode in two minutes. The alarm clears when the load drops below 5% of the set point.
Output Overload Level 3 (Alarm 162) Continuous Alarm	The load is >110% of the UPS rating.	Remove some of the equipment from the UPS. The UPS continues to operate, but transfers to Fault mode in 300 ms to one second. The alarm clears when the load drops below 5% of the set point.
Battery DC Over Voltage (Alarm 68) Continuous Alarm	Battery voltage levels have exceeded the maximum allowable limits.	The UPS turns off the charger until the next power recycle. Contact your service representative.
Charger Failure (Alarm 34) Continuous Alarm	A battery charger fault has been detected.	The UPS turns off the charger until the next power recycle. Contact your service representative.
Inverter AC Over Voltage (Alarm 0) Continuous Alarm	The UPS has detected abnormally high inverter voltage levels.	The UPS transfers to Bypass mode if supporting the load.
Inverter AC Under Voltage (Alarm 1) Continuous Alarm	The UPS has detected abnormally low inverter voltage levels.	The UPS transfers to Bypass mode if supporting the load.
Rectifier Input Over Current (Alarm 26) Continuous Alarm	The UPS has detected that rectifier input current limits have been exceeded.	The UPS transfers to Bypass mode if supporting the load.
Inverter Output Over Current (Alarm 27) Continuous Alarm	The UPS has detected that the inverter output current limits have been exceeded.	The UPS transfers to Bypass mode if supporting the load.

Table 15. Typical Alarms and Conditions (continued)

Alarm or Condition	Possible Cause	Action
DC Link Over Voltage (Alarm 28) Continuous Alarm	The link or rail voltage has exceeded its upper threshold limit.	The UPS transfers to Bypass mode if supporting the load.
DC Link Under Voltage (Alarm 29) Continuous Alarm	The link or rail voltage has dropped below its lower threshold limit.	The UPS transfers to Bypass mode if supporting the load.
Rectifier Fault (Alarm 30) Continuous Alarm	The UPS has detected a fault in the rectifier circuit while attempting recovery from Bypass mode or Converter mode.	Contact your service representative.
Inverter Fault (Alarm 31) Continuous Alarm	The UPS has detected a fault in the inverter circuit while attempting a recovery from Bypass mode or Converter mode.	Contact your service representative.
Fatal EEPROM Fault (Alarm 53) Continuous Alarm	There is EEPROM data corruption due to a failed device or incorrect flash upgrade.	Contact your service representative.
Output Short Circuit (Alarm 58) Continuous Alarm	The UPS has detected an abnormally low impedance placed on its output and considers it a short circuit.	If the UPS is in Normal mode, the UPS transfers to Bypass mode if available, otherwise, the UPS shuts down after five line cycles. If the UPS is in Battery mode, the UPS shuts down after five line cycles.
Fan Failure (Alarm 193) Continuous Alarm	The UPS has detected that one or more fans are not functioning properly.	This is an alarm only. Contact your service representative immediately and remove the load.

Silencing the Alarm

Press any button on the control panel to silence the alarm. Check the alarm condition and perform the applicable action to resolve the condition. If any new alarm becomes active, the audible alarm resumes, overriding the previously silenced alarm.